



www.lumex.ba

KATALOG VIJČANE ROBE

LUMEX D.O.O.

Sadržaj

1.VIJCI S METRIČKIM NAVOJEM

23.VIJCI ZA DRVO I MERICU

33.VIJCI ZA LIM

41.PVC PROGRAM I STOLARIJA

43.TIPLE I ANKERI

48.SUHA GRADNJA

52.NOSAČI

62. NAVRTKE

75.PODLOŠKE

82.NAVOJNE ŠIPKE

85.POP NITNE

88.OSTALO

96. INOX



LUMEX
D.O.O





LUMEX
D.O.O



VIJCI S METRIČKIM NAVOJEM

01

VIJCI S METRIČKIM NAVOJEM

Vijak sa šestougaonom glavom (cijeli navoj)

DIN 933 KV.5.6.

Bijeli cink



LUMEX
D.O.O



Dimenzije	Dimenzije	Dimenzije	Dimenzije
4x10	6x10	8x16	10x20
4x16	6x12	8x20	10x25
4x20	6x16	8x25	10x30
4x25	6x20	8x30	10x35
4x30	6x25	8x35	10x40
4x40	6x30	8x40	10x45
5x10	6x35	8x45	10x50
5x12	6x40	8x50	10x55
5x16	6x45	8x55	10x60
5x20	6x50	8x60	10x70
5x25	6x60	8x70	10x80
5x30	6x70	8x80	10x90
5x35	6x80	8x90	10x100
5x40	6x90	8x100	10x120
5x50	6x100	8x120	12x20
5x60	8x12	10x16	12x25

VIJCI S METRIČKIM NAVOJEM

Vijak sa šestougaonom glavom (Cijeli navoj)

DIN 933 KV.5.6.

Bijeli cink



LUMEX
D.O.O



Dimenzije
12x30
12x35
12x40
12x45
12x50
12x55
12x60
12x70
12x80
12x90
12x100
12x120
14x30
14x35
14x40
14x45

Dimenzije
14x50
14x60
14x70
14x80
14x90
14x100
16x30
16x35
16x40
16x45
16x50
16x55
16x60
16x70
16x80
16x90
16x100

VIJCI S METRIČKIM NAVOJEM

Vijak sa šestougaonom glavom (cijeli navoj)

DIN 933 KV.8.8.

Bijeli cink



LUMEX
D.O.O



Dimenzije	Dimenzije	Dimenzije	Dimenzije
4×10	5×40	8×12	10×20
4×12	5×50	8×16	10×25
4×16	6×10	8×20	10×30
4×20	6×12	8×25	10×35
4×25	6×16	8×30	10×40
4×30	6×20	8×35	10×45
4×35	6×25	8×40	10×50
4×40	6×30	8×50	10×60
4×50	6×35	8×60	10×70
5×10	6×40	8×70	10×80
5×12	6×50	8×80	10×90
5×16	6×60	8×90	10×100
5×20	6×70	8×100	10×120
5×25	6×80	8×120	10×150
5×30	6×90	8×140	12×20
5×35	6×100	8×150	12×25

VIJCI S METRIČKIM NAVOJEM

Vijak sa šestougaonom glavom (Cijeli navoj)

DIN 933 KV.8.8.

Bijeli cink



LUMEX
D.O.O.



Dimenzije	Dimenzije	Dimenzije	Dimenzije	Dimenzije
12×30	14×45	16×80	20×60	24×120
12×35	14×50	16×90	20×70	24×140
12×40	14×60	16×100	20×80	27×60
12×45	14×70	16×110	20×90	27×70
12×50	14×80	16×120	22×50	27×80
12×60	14×90	16×130	22×80	27×100
12×70	14×100	16×140	22×100	30×50
12×80	14×120	18×40	22×120	30×60
12×90	14×150	18×50	22×130	30×70
12×100	16×30	18×60	22×140	30×80
12×120	16×35	18×70	24×50	30×90
12×140	16×40	18×80	24×60	30×100
12×150	16×45	18×100	24×70	30×120
14×30	16×50	18×120	24×80	30×150
14×35	16×60	20×40	24×90	
14×40	16×70	20×50	24×100	

VIJCI S METRIČKIM NAVOJEM

Vijak sa šestougaonom glavom (Cijeli navoj)

DIN 933 KV.10.9.
Crni



LUMEX
D.O.O



Dimenzije
8x20
8x25
8x30
8x35
8x40
8x50
10x20
10x25
10x30
10x35
10x40
10x50
10x60
10x70
10x80
12x25

Dimenzije
12x30
12x35
12x40
12x50
12x60
12x70
12x80
14x30
14x40
14x50
16x30
16x35
16x40
16x45
16x50
16x60

Dimenzije
16x70
16x80
20x50
20x60
20x70
20x80

VIJCI S METRIČKIM NAVOJEM

Vijak sa šestougaonom glavom (djelimični navoj)

DIN 931 KV.8.8.

Bijeli cink



LUMEX
D.O.O



Dimenzije	Dimenzije	Dimenzije	Dimenzije
6x50	8x130	10x180	14x140
6x60	8x140	10x200	14x150
6x70	8x150	12x40	14x180
6x80	10x40	12x50	14x200
6x90	10x50	12x60	16x45
6x100	10x55	12x110	16x50
8x40	10x60	12x120	16x60
8x50	10x70	12x160	16x65
8x55	10x80	12x180	16x70
8x60	10x90	12x200	16x80
8x70	10x100	14x50	16x90
8x80	10x120	14x60	16x100
8x90	10x130	14x70	16x110
8x100	10x140	14x80	16x120
8x110	10x150	14x120	16x130
8x120	10x160	14x130	16x140

VIJCI S METRIČKIM NAVOJEM

Vijak sa šestougaonom glavom (djelimični navoj)

DIN 931 KV.8.8.

Bijeli cink



LUMEX
D.O.O



Dimenzije	Dimenzije	Dimenzije	Dimenzije	Dimenzije
16x150	20x70	20x300	24x200	30x130
16x160	20x80	22x80	24x220	30x140
16x180	20x90	22x100	24x240	30x150
16x200	20x100	22x120	24x260	30x180
16x220	20x110	22x150	24x300	30x200
16x250	20x120	22x200	27x80	
16x300	20x130	24x60	27x100	
18x60	20x140	24x70	27x120	
18x70	20x150	24x80	27x150	
18x80	20x160	24x90	27x200	
18x90	20x170	24x100	30x70	
18x100	20x180	24x120	30x80	
18x110	20x200	24x140	30x90	
18x120	20x220	24x150	30x100	
18x150	20x240	24x160	30x110	
20x60	20x250	24x180	30x120	

VIJCI S METRIČKIM NAVOJEM

Vijak sa šestougaonom glavom (djelimični navoj)

DIN 931 KV.10.9.

Crni



LUMEX
D.O.O



Dimenzije	Dimenzije	Dimenzije	Dimenzije
8x50	12x60	16x70	18x120
8x60	12x70	16x80	18x150
8x70	12x80	16x90	18x180
8x80	12x90	16x100	18x200
8x90	12x100	16x110	20x60
8x100	12x120	16x120	20x70
8x120	12x150	16x130	20x80
10x50	12x180	16x140	20x90
10x60	12x200	16x150	20x100
10x70	14x50	16x160	20x110
10x80	14x60	16x180	20x120
10x90	14x70	16x200	20x130
10x100	14x80	18x60	20x140
10x120	14x100	18x70	20x150
10x150	14x120	18x80	20x160
12x50	16x60	18x100	20x180

VIJCI S METRIČKIM NAVOJEM

Vijak sa šestougaonom glavom (djelimični navoj)

DIN 931 KV.10.9.

Crni



LUMEX
D.O.O



Dimenzije	Dimenzije
20x200	24x160
20x250	24x180
22x60	24x200
22x80	24x250
22x100	30x80
22x120	30x90
22x150	30x100
24x70	30x120
24x80	30x150
24x90	30x180
24x100	30x200
24x110	
24x120	
24x130	
24x140	
24x150	

VIJCI S METRIČKIM NAVOJEM

Vijak imbus sa cilindričnom glavom

DIN 912 KV.8.8.

Bijeli cink



LUMEX
D.O.O



Dimenzije
6x12
6x16
6x20
6x25
6x30
6x40
6x50
8x16
8x20
8x25
8x30
8x35
8x40
8x45
8x50
8x60

Dimenzije
8x70
8x80
8x90
8x100
10x20
10x25
10x30
10x35
10x40
10x50
10x60
10x70
10x80
12x30
12x35
12x40

Dimenzije
12x50
12x60
12x70
12x80

VIJCI S METRIČKIM NAVOJEM

Vijak imbus sa cilindričnom glavom

DIN 912 KV.8.8.

Crni



LUMEX
D.O.O



Dimenzije	10x25
5x10	10x30
5x12	10x40
5x16	10x50
5x20	10x60
6x12	10x70
6x16	12x25
6x20	12x30
6x30	12x40
8x16	12x50
8x20	12x60
8x25	12x70
8x30	12x80
8x40	16x40
8x50	16x50
8x60	16x60
10x20	16x70

VIJCI S METRIČKIM NAVOJEM

Vijak sa upuštenom glavom (krstasti urez)

DIN 965
Bijeli cink



LUMEX
D.O.O

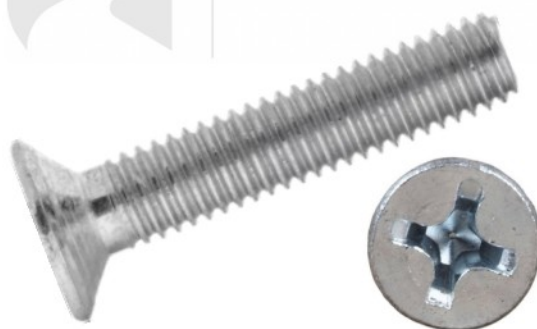

Dimenzije	Dimenzije	Dimenzije	Dimenzije	Dimenzije
3x6	4x30	5x50	6x50	10x30
3x8	4x35	5x55	6x60	10x40
3x10	4x40	5x60	6x70	10x50
3x12	4x45	5x70	6x80	10x60
3x16	4x50	5x80	8x16	10x65
3x20	4x60	5x90	8x20	
3x25	5x8	5x100	8x25	
3x30	5x10	6x10	8x30	
3x40	5x12	6x12	8x35	
4x6	5x16	6x16	8x40	
4x8	5x20	6x20	8x45	
4x10	5x25	6x25	8x50	
4x12	5x30	6x30	8x60	
4x16	5x35	6x35	8x70	
4x20	5x40	6x40	8x80	
4x25	5x45	6x45	10x25	

VIJCI S METRIČKIM NAVOJEM

Vijak sa cilindričnom glavom (ravni urez)

DIN 84
Bijeli cink



LUMEX
D.O.O



Dimenzije	Dimenzije	Dimenzije
3x5	4x30	5x60
3x6	4x35	6x10
3x8	4x40	6x12
3x10	4x50	6x16
3x12	4x60	6x20
3x16	5x6	6x25
3x20	5x8	6x30
3x25	5x10	6x35
3x30	5x12	6x40
4x6	5x16	6x45
4x8	5x20	6x50
4x10	5x25	6x60
4x12	5x30	8x25
4x16	5x40	8x70
4x20	5x45	
4x25	5x50	

VIJCI S METRIČKIM NAVOJEM

Vijak sa cilindričnom glavom (krstasti urez)

DIN 7985

Bijeli cink



LUMEX
D.O.O



Dimenzije	Dimenzije	Dimenzije	Dimenzije	Dimenzije
3x5	4x6	5x12	6x30	8x60
3x6	4x8	5x16	6x35	8x70
3x8	4x10	5x20	6x40	8x80
3x10	4x12	5x25	6x45	
3x12	4x16	5x30	6x50	
3x16	4x20	5x35	6x55	
3x20	4x25	5x40	6x60	
3x25	4x30	5x45	8x12	
3x30	4x35	5x50	8x16	
3x35	4x40	5x55	8x20	
3x40	4x45	5x60	8x25	
3x45	4x50	6x10	8x30	
3x50	4x60	6x12	8x35	
3.5x6	5x6	6x16	8x40	
3.5x8	5x8	6x20	8x45	
3.5x10	5x10	6x25	8x50	

VIJCI S METRIČKIM NAVOJEM

Torban vijak

DIN 603
Bijeli cink



LUMEX
D.O.O



Dimenzije	Dimenzije	Dimenzije	Dimenzije	Dimenzije
5x16	6x40	8x35	10x20	12x70
5x20	6x45	8x40	10x25	12x80
5x25	6x50	8x45	10x30	12x90
5x30	6x55	8x50	10x40	12x100
5x35	6x60	8x55	10x45	12x120
5x40	6x65	8x60	10x50	
5x45	6x70	8x65	10x60	
5x50	6x80	8x70	10x70	
5x60	6x90	8x75	10x80	
5x70	6x100	8x80	10x90	
6x12	6x110	8x90	10x100	
6x16	6x120	8x100	10x120	
6x20	6x150	8x120	10x150	
6x25	8x20	8x130	12x40	
6x30	8x25	8x140	12x50	
6x35	8x30	8x150	12x60	

VIJCI S METRIČKIM NAVOJEM

Vijak imbus sa upuštenom glavom

DIN 7991 KV.10.9. / KV.8.8.

Bijeli cink, brunirano



LUMEX
D.O.O



Dimenzije
6x16
6x20
6x25
6x30
6x40
8x16
8x20
8x25
8x30
8x35
8x40
8x50
8x60
8x70
8x80
10x20

Dimenzije
10x25
10x30
10x35
10x40
10x50
12x30
12x35
12x40
12x50

VIJCI S METRIČKIM NAVOJEM

Vijak imbus sa upuštenom glavom

DIN 7991 KV.12.9.

Crni



Dimenzije	10x25
5x10	10x30
5x12	10x40
5x16	10x50
5x20	10x60
6x12	10x70
6x16	12x25
6x20	12x30
6x30	12x40
8x16	12x50
8x20	12x60
8x25	12x70
8x30	12x80
8x40	16x40
8x50	16x50
10x20	16x60
8x60	16x70

VIJCI S METRIČKIM NAVOJEM

Vijak imbus sa cilindričnom glavom (niska glava)

DIN 7984 M.B1.125 ISO 14580

Materijal:čelik Kvalitet: 8,8 10,9
Zaštita:pocinčano (Zn) ,brunirano (Br)
Dimenzije: d(M): M8, M10, M12, M14, M16, M18, M20, M22, M24 l(mm): 16mm-150mm

Vijak imbus sa cilindričnom glavom (niska glava)

DIN 6912 M.B1.124

Materijal:čelik Kvalitet: 8,8 10.9
Zaštita:pocinčano (ZN),brunirano (Br)
Dimenzije: d(M): M4, M8, M10, M12, M14, M16, M18, M20, M22, M24 l(mm): 10mm-150mm

Imbus vijak, ravna (lećasta) glava (sa podloškom)

ISO 7380 1/2

Materijal :čelik /inox
Zaštita.pocinčani (ZN) i brunirani (Br)



LUMEX
D.O.O



VIJCI S METRIČKIM NAVOJEM

Plug vijak

DIN 604 M.B1.150

Materijal: čelik Kvalitet: 5.8 8.8

Zaštita: pocinačno (ZN), brunirano (Br)

Dimenzije: d(M): M10, M12, M16, M20,

M24 l(mm): 30mm-150mm

Vijak sa šestougaonom glavom i podloškom

DIN 6921 ISO 8100

Materijal: čelik Kvalitet: 8,8; 10,9

Zaštita: pocinčano (ZN)

Dimenzije: d(M): M6, M8, M10, M12

l(mm): 10mm-50mm

Leptir vijak

DIN 316

Materijal: čelik/inox



LUMEX
D.O.O



VIJCI S METRIČKIM NAVOJEM

Vijak sa upuštenom glavom (ravni urez)

DIN 963 M.B1.130 ISO 2009

Materijal: čelik Kvalitet: 5.8 Zaštita:
pocinčano (ZN)

Dimenzije: d(M): M3, M4, M5, M6, M8,
M10, M12 l(mm): 6mm-100mm

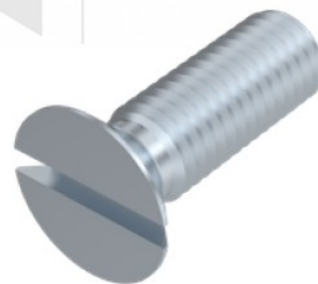

Vijci za raonik

Materijal: čelik

Zaštita: brunirani (BR)



VIJCI S METRIČKIM NAVOJEM

Vijci za skelu

1/2x73

DIN 898

Žuti cink



VIJCI S METRIČKIM NAVOJEM

Vijak za fioke (ručice)



LUMEX
D.O.O



Dimenzije
4x8
4x10
4x12
4x14
4x16
4x20
4x22
4x25
4x32
4x35
4x38
4x40
4x45
4x50
4x60

LUMEX

**VIJCI ZA
DRVO I
IVERICU**

02



VIJCI ZA DRVO I IVERICU

Vijak za drvo sa šestougaonom glavom

DIN 571
Bijeli cink



Dimenzije
6x30
6x40
6x50
6x60
6x70
6x80
6x90
6x100
6x110
6x120
6x140
6x150
6x180
6x200
8x40
8x50

Dimenzije
8x60
8x70
8x80
8x90
8x100
8x120
8x140
8x150
8x160
8x180
8x200
8x220
8x250
10x60
10x70
10x80

Dimenzije
10x90
10x100
10x120
10x150
10x180
10x200
10x220
10x250
10x300
12x80
12x100
12x120
12x150
12x180
12x200
12x220

Dimenzije
12x250
12x300

VIJCI ZA DRVO I IVERICU

Vijak za ivericu

DIN 7505

Žuti i bijeli cink 1/1 navoj



LUMEX

D.O.O



Dimenzije	3.5x35	4.5x30	5x90
3x12	3.5x40	4.5x35	6x30
3x16	3.5x45	4.5x40	6x35
3x18	3.5x50	4.5x45	6x40
3x20	4x16	4.5x50	6x45
3x25	4x18	4.5x60	6x50
3x30	4x20	4.5x70	6x60
3x35	4x25	5x20	6x70
3x40	4x30	5x25	6x80
3.5x12	4x35	5x30	6x90
3.5x13	4x40	5x35	6x100
3.5x15	4x45	5x40	6x120
3.5x16	4x50	5x45	6x130
3.5x18	4x60	5x50	6x140
3.5x20	4x70	5x55	6x150
3.5x25	4.5x20	5x60	6x160
3.5x30	4.5x25	5x70	6x170
		5x80	6x180
			6x190
			6x200

VIJCI ZA DRVO I IVERICU

Vijak za ivericu

DIN 7505

Žuti i bijeli cink 1/2
navoj



LUMEX

D.O.O

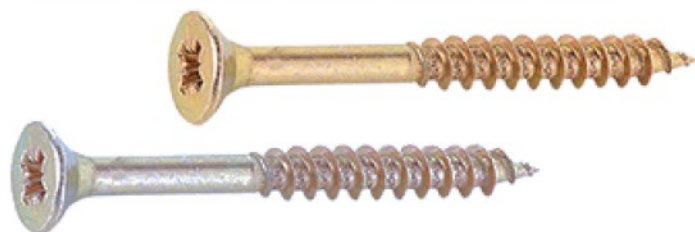

Dimenzije

3x40

3.5x30

3.5x45

3.5x50

4x60

4x70

4x80

4.5x60

4.5x70

4.5x80

5x60

5x70

5x80

5x90

5x100

5x120

Dimenzije

6x80

6x90

6x100

6x120

6x140

6x150

6x160

6x180

6x200

VIJCI ZA DRVO I IVERICU

Iver vijak za tvrdo drvo LIH LIN



LUMEX
D.O.O



Dimenzije	3.5x35	4.5x30	5x90
3x12	3.5x40	4.5x35	6x30
3x16	3.5x45	4.5x40	6x35
3x18	3.5x50	4.5x45	6x40
3x20	4x16	4.5x50	6x45
3x25	4x18	4.5x60	6x50
3x30	4x20	4.5x70	6x60
3x35	4x25	5x20	6x70
3x40	4x30	5x25	6x80
3.5x12	4x35	5x30	6x90
3.5x13	4x40	5x35	6x100
3.5x15	4x45	5x40	6x120
3.5x16	4x50	5x45	6x130
3.5x18	4x60	5x50	6x140
3.5x20	4x70	5x55	6x150
3.5x25	4.5x20	5x60	6x160
3.5x30	4.5x25	5x70	6x170
		5x80	6x180
			6x190
			6x200

VIJCI ZA DRVO I IVERICU

Iver vijak torx



TORX

Dimenzije
4,5X30/18
4,5X35/21
4,5X40/25
4,5X50/30
4,5X60/35
4,5X70/45
4,5X80/48
4X20
4X25
4X30/18
4X35/21
4X40/25
4X45/28
4X50/30
4X60/35
4X70/45

Dimenzije
5X100/60
5X120/60
5X30/18
5X40/25
5X45/28
5X45/28
5X50/30
5X60/35
5X70/45
5X80/48
5X90/48
6X100/60
6X120/60
6X140/60

Dimenzije
6X100/60
6X120/60
6X140/60
6X150/60
6X160/60
6X180/60
6X200/60
6X240/60
6X50/30
6X60/35
6X70/45
6X80/48
6X90/48

VIJCI ZA DRVO I IVERICU

Vijci za grede

Žuti cink



LUMEX
D.O.O.

Tanjirasti	Tanjirasti
6x40	8x180
6x50	8x200
6x60	8x220
6x70	8x240
6x80	8x260
6x100	8x280
6x120	8x300
6x140	8x320
6x160	8x340
6x180	
6x200	
8x80	
8x100	
8x120	
8x140	
8x160	



VIJCI ZA DRVO I IVERICU

Vijci za grede sa upuštenom glavom

Žuti cink



LUMEX
D.O.O



Dimenzije
4,5X40
4,5X40
4,5X50
4,5X60
4,5X70
4X30
4X35
4X40
4X45
4X60
4X70
4X80

Dimenzije
5X100
5X50
5X80
5X90

Dimenzije
6X100
6X140
6X160
6X200
6X220
6X240
6X260
6X280
6X300
6X50
6X70
6X80

Dimenzije
8X220
8X240
8X260
8X280
8X80
8X100
8X140
8X200

Vijak za skelu okasti

Dimenzije : D: 12 L
(MM): 120-400



LUMEX
D.O.O.



Metalni anker za štokove

Zaštita: pocinčano (ZN)

Dimenzije:

- 10x72mm,
- 10x92mm,
- 10x112mm,
- 10x132mm,
- 10x152mm,
- 10x182mm,
- 10x202mm



Tipla sa vijkom sa šestougaonom glavom

- 10×80 mm
- 10×100 mm
- 10×120 mm
- 10×140 mm
- 10×160 mm
- 10×180 mm
- 10×200 mm



VIJCI SAMOUREZUJUĆI

Vijak sa podloškom u boji - za drvo i za metal

Crvena: RAL 3009

Zelena: RAL 6005 / RAL 6028

Antracit: RAL 7016

Braon: RAL 8017

Tamno braon: RAL 8019

Prljavo bijela: RAL 9002

Srebrna: RAL 9006

Bijela: RAL 9010

Crna: RAL 9005



- 4,8x25 mm
- 4,8x35 mm
- 4,8x38 mm
- 4,8x50 mm
- 4,8x70 mm
- 4,8x80 mm



LUMEX
D.O.O

VIJCI SAMOUREZUJUĆI

Vijak za lim ETANCO

- 4,8x19 mm
- 4,8x25 mm
- 4,8x35 mm
- 4,8x38 mm
- 4,8x50 mm
- 4,8x70 mm

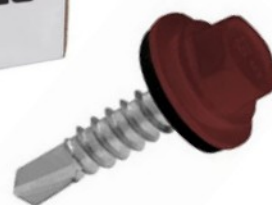

LUMEX

**VIJCI ZA
LIM**

03



VIJCI ZA LIM

Vijak za lim (ravna glava)

DIN 7981

Bijeli cink



LUMEX
D.O.O



Dimenzije
2.9x6.5
2.9x9.5
2.9x13
2.9x16
2.9x19
2.9x22
2.9x25
3.5x6.5
3.5x9.5
3.5x13
3.5x16
3.5x19
3.5x22
3.5x25
3.5x32
3.9x6.5

Dimenzije
3.9x9.5
3.9x13
3.9x16
3.9x19
3.9x22
3.9x25
3.9x32
3.9x38
4.2x9.5
4.2x13
4.2x16
4.2x19
4.2x22
4.2x25
4.2x32
4.2x38

Dimenzije
4.2x50
4.8x9.5
4.8x13
4.8x16
4.8x19
4.8x22
4.8x25
4.8x32
4.8x38
4.8x50
5.5x13
5.5x16
5.5x19
5.5x22
5.5x25
5.5x32

Dimenzije
5.5x38
5.5x50
6.3x13
6.3x16
6.3x19
6.3x22
6.3x25
6.3x32
6.3x38
6.3x45
6.3x50
6.3x60
6.3x70

VIJCI ZA LIM

Vijak za lim (upuštena glava)

DIN 7982

Bijeli cink



LUMEX

D.O.O



Dimenzije	Dimenzije	Dimenzije
2.9x6.5	3.9x13	4.2x45
2.9x9.5	3.9x16	4.8x13
2.9x13	3.9x19	4.8x16
2.9x16	3.9x22	4.8x19
2.9x19	3.9x25	4.8x22
2.9x22	3.9x32	4.8x25
2.9x25	3.9x38	4.8x32
3.5x6.5	3.9x45	4.8x38
3.5x9.5	4.2x9.5	4.8x45
3.5x13	4.2x13	4.8x50
3.5x16	4.2x16	5.5x19
3.5x19	4.2x19	5.5x38
3.5x22	4.2x22	6.3x38
3.5x25	4.2x25	6.3x70
3.5x32	4.2x32	
3.9x9.5	4.2x38	

VIJCI ZA LIM

vijak za lim ravna glava



LUMEX

D.O.O



Dimenzije

4.2x13

4.2x16

4.2x19

4.2x25

4.2x32

4.2x40

4.2x50

VIJCI SAMOUREZUJUĆI

Vijak za lim samourezivi (šestougaona glava - oblik K)



LUMEX
D.O.O



Dimenzije	Dimenzije	Dimenzije
4.2x13	5.5x25	6.3x80
4.2x16	5.5x32	6.3x90
4.2x19	5.5x38	6.3x100
4.2x22	5.5x50	6.3x110
4.2x25	5.5x60	6.3x120
4.2x32	5.5x70	6.3x140
4.2x38	5.5x80	6.3x150
4.8x16	6.3x19	6.3x160
4.8x19	6.3x22	6.3x180
4.8x25	6.3x25	6.3x200
4.8x32	6.3x32	6.3x220
4.8x35	6.3x38	6.3x250
4.8x38	6.3x45	
4.8x50	6.3x50	
4.8x70	6.3x60	
5.5x19	6.3x70	

VIJCI SAMOUREZUJUĆI

Vijak za lim samourezivi (upuštena glava - oblik P)

DIN 7504



LUMEX
D.O.O



Dimenzije	Dimenzije
3.9x13	4.8x35
3.9x16	4.8x38
3.9x19	4.8x50
3.9x22	4.8x60
3.9x25	4.8x70
3.9x32	4.8x80
3.9x38	5.5x19
4.2x16	5.5x25
4.2x19	5.5x32
4.2x25	5.5x38
4.2x32	5.5x50
4.2x38	5.5x60
4.2x50	5.5x70
4.8x16	5.5x80
4.8x19	6.3x25
4.8x25	6.3x32
4.8x32	6.3x38

VIJCI SAMOUREZUJUĆI

Vijak za lim samourezivi (cilindrična glava - oblik N)

DIN 7504



LUMEX
D.O.O.



Dimenzije	Dimenzije	Dimenzije
3.5x13	4.8x16	5.5x70
3.5x16	4.8x19	5.5x80
3.5x19	4.8x25	6.3x25
3.9x13	4.8x32	6.3x32
3.9x16	4.8x35	6.3x38
3.9x19	4.8x38	
3.9x22	4.8x50	
3.9x25	4.8x60	
3.9x32	4.8x70	
3.9x38	4.8x80	
4.2x16	5.5x19	
4.2x19	5.5x25	
4.2x25	5.5x32	
4.2x32	5.5x38	
4.2x38	5.5x50	
4.2x50	5.5x60	

VIJCI SAMOUREZUJUĆI

Vijci za lim sa proširenom glavom - samourezivi



LUMEX
D.O.O



Dimenzije
4.2x13
4.2x16
4.2x19
4.2x25
4.2x32
4.2x38

LUMEX



**PVC
PROGRAM I
STOLARIJA**

04

VIJCI ZA PVC

Vijci za PVC



LUMEX

Dimenzije

4.1x25

4.1x30

4.1x35

4.1x40

4.1x45

4.1x50

Turbo vijak

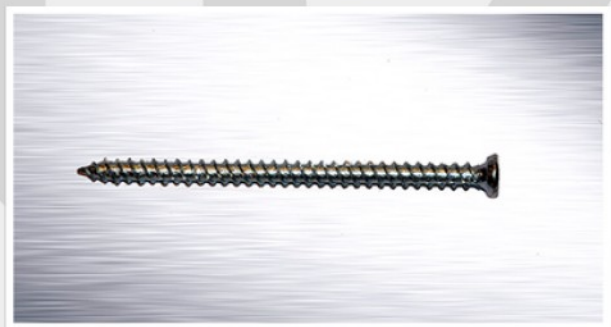

Dimenzije

7,5x52

7,5x72

7,5x92

7,5x112

7,5x132

7,5x152

7,5x182

7,5x202

7,5x212

7,5x232

7,5x252

LUMEX

**TIPLE I
ANKERI**
05



TIPLE I ANKERI

Vijak ukucavajući sa tiplom

Dimenzije		
6 x 40	8 x 60	10 x 80
6 x 50	8 x 80	10 x 100
6 x 60	8 x 100	10 x 120
6 x 80	8 x 120	10 x 140
6 x 100	8 x 140	



Vijak ukucavajući sa širokom kragom

KOELNER

6 x 40



Produžena tipla



Dimenzije		
8 x 80	10 x 140	12 x 160
8 x 100	10 x 160	12 x 180
8 x 120	12 x 80	12 x 200
10 x 80	12 x 100	14 x 140
10 x 100	12 x 120	14 x 160
10 x 120	12 x 140	16 x 100
		16 x 130
		16 x 160

PVC tipla

Dimenzije
M6
M8
M10
M12
M14



puz tipla za gips ploce 14x22



LUMEX
D.O.O

Čelična tipla za beton



Gužvajuće tipla

Dimenzije
M6
M8
M10
M12
M14

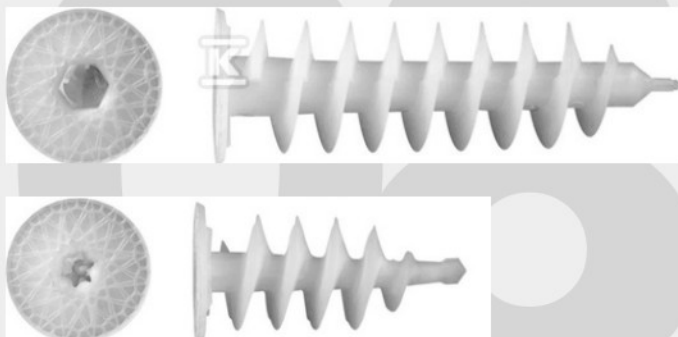

Dimenzije
M6
M8
M10
M12
M14
M16
M20



Tipla za stiropor

Dimenzije
25x50
25x90

09

TIPLE I ANKERI
Vijak sidreni (anker vijak)



Dimenzije	Dimenzije	Dimenzije
8x65	12x135	20x150
8x80	12x150	20x160
8x95	12x160	20x180
8x120	12x180	20x200
8x150	12x200	20x250
10x80	12x250	20x300
10x90	12x300	24x160
10x95	14x130	24x200
10x100	16x100	24x220
10x120	16x120	24x240
10x150	16x150	24x260
10x180	16x180	24x300
10x200	16x200	
12x80	16x250	
12x100	16x300	
12x120	20x120	

LUMEX



SUHA GRADNJA

06

SUHA GRADNJA

Vijak za gipsane ploče

- Fini navoj (metalna konstrukcija)
- Grubi navoj (drvena konstrukcija)
- Samourezivi



LUMEX
D.O.O



Namjena i Dimenzije

DRVO 3.5x25

DRVO 3.5x35

DRVO 3.5x45

DRVO 3.5x55

DRVO 4.2x75

DRVO 4.2x95

SAMOUREZIVI 3.5x25

SAMOUREZIVI 3.5x35

SAMOUREZIVI 3.5x45

Metal 3.5x25

Metal 3.5x35

Metal 3.5x45

Metal 3.5x55

Metal 3.5x75

Certificirani za metal 3.5x25

Certificirani za metal 3.5x35

Konfirmat vijak

5x50

7x50



Natezni vijak

Dimenzije	M16
M6	M20
M8	M24
M10	
M12	
M14	



LUMEX
D.O.O.



Vijak okasti

Dimenzije	M18
M8	M20
M10	M24
M12	M30
M14	
M16	



05

Hangar vijak



LUMEX
D.O.O



Namjena i Dimenzije	Namjena i Dimenzije	Namjena i Dimenzije
DRVO (D.D.) 6x70	METAL/DRVO. 6x70	METAL/UNIV. 10x120
DRVO (D.D.) 6x80	METAL/DRVO. 6x80	METAL/UNIV. 10x140
DRVO (D.D.) 6x90	METAL/DRVO 6x90	
DRVO (D.D.) 8x80	METAL/DRVO 8x60	
DRVO (D.D.) 8x90	METAL/DRVO. 8x70	
DRVO (D.D.) 8x100	METAL/DRVO 8x80	
DRVO (D.D.) 8x120	METAL/DRVO. 8x90	
	METAL/DRVO 8x100	
	METAL/DRVO. 8x120	
	METAL/DRVO. 8x140	
	METAL/DRVO. 8x150	
	METAL/DRVO. 8x180	
	METAL/DRVO. 8x200	
	METAL/DRVO. 10x80	
	METAL/DRVO. 10x90	
	METAL/DRVO. 10x100	

LUMEX

NOSAČI

07



NOSAČI



Dimenzije

UGAO 80X80X80 2MM

UGAO 90X90X90 2MM

UGAO 90X90X90 2,5MM

UGAO 100X100X100 2MM

UGAO 100X100X100 2,5MM

Dimenzije

VEZNA PLOČA 250X160 2MM

VEZNA PLOČA 250X160 2,5MM

VEZNA PLOČA 250X140 2MM

VEZNA PLOČA 250X140 2,5MM

VEZNA PLOČA 250X120 2MM

VEZNA PLOČA 250X120 2,5MM

NOSAČI



Dimenzije

UGAO 40X40X40 2MM



Dimenzije

UGAO 80X80X60 2MM

UGAO 80X80X70 2MM

NOSAČI



Dimenzije

UGAO 40X40X40 2MM



Dimenzije

UGAO 80X80X60 2MM

UGAO 80X80X70 2MM



Dimenzije

UGAO 100X100X60 2MM

UGAO 100X100X70 2MM

UGAO 100X100X80 2MM

NOSAČI



Dimenzije

NAUGLICA 40X40 1MM

NAUGLICA 60x60 1MM

NAUGLICA 80X80 1MM

NAUGLICA 100X100 1MM

NAUGLICA 150X150 1,5MM

Dimenzije

VEZNA PLOČA 69X30 1,25MM

VEZNA PLOČA 69X30 1,5MM

VEZNA PLOČA 69X25 1,5MM

NOSAČI



Dimenzije

UGAO 100X100X120 2MM

UGAO 100X100X120 2,5MM

UGAO 100X100X140 2MM

UGAO 100X100X140 2,5MM

UGAO 100X100X160 2MM

UGAO 100X100X160 2,5MM

Dimenzije

VEZNA PLOČA 160X60 2MM

VEZNA PLOČA 200X60 2MM

VEZNA PLOČA 200X90 2MM

Dimenzije

UGAO 60 X60X 40 2MM

NOSAČI



Dimenzije

UGAO 20X20X15 1,25MM

UGAO 30X30X15 1,25MM

UGAO 40X40X15 1,5MM

UGAO 50X50X15 1,5MM

UGAO 50X50X15 2MM

UGAO 60X60X25 2MM

UGAO 80X80X25 2MM

UGAO 100X100X25 2MM

Dimenzije

VEZNA PLOČA 80X40 2MM

VEZNA PLOČA 120X40 2MM

VEZNA PLOČA 160X40 2MM

VEZNA PLOČA 160X50 2MM

VEZNA PLOČA 200X50 2MM

Dimenzije

UGAO 80X40X40 2MM

NOSAČI



Dimenzije

UGLIĆ 80X50 2MM



Dimenzije

UGAO 50X50X40 2MM

UGAO 50X50X50 2MM



Dimenzije

UGAO 80X80X50 2MM

NOSAČI



Dimenzije

NOSAČ KLIME 12 1,5MM

NOSAČ KLIME 12 2MM

NOSAČ KLIME 18 1,5MM

NOSAČ KLIME 18 2MM

NOSAČ KLIME 18 2,5MM

Dimenzije

VEZNA PLOČA 60X15X1,5

VEZNA PLOČA 100X15X1,5

VEZNA PLOČA 160X25X2

Dimenzije

UGAO 60X60X60 2MM

NOSAČI



Dimenzije

KUTNIK ZA KREKET 100MM

KUTNIK ZA KREKET 130MM

PRIHVATNIK ZA BRAVU KUTNI

PRIHVATNIK ZA BRAVU

RAVNI KRATKI

LUMEX



NAVRTKE

08

NAVRTKE

Navrtka šestougaona

DIN 934

Bijeli cink, crna



LUMEX
2010



KV.8.8.	M18	Korak 1.5
M3	M20	M10
M4	M22	M12
M5	M24	M14
M6	M27	M16
M8	M30	M18
M10	M33	M20
M12	M36	
M14		
M16		

KV.10.9.	M20
M8	M22
M10	M24
M12	M27
M14	M30
M16	
M18	

NAVRTKE

Navrtka samokočiva

DIN 985

Bijeli cink, crna



LUMEX

D.O.O



KV.8.8.	M18
M4	M20
M5	M22
M6	M24
M8	M27
M10	M30
M12	
M14	
M16	

KV.10.9.	M20
M6	M22
M8	M24
M10	M27
M12	M30
M14	
M16	
M18	

NAVRTKE

Navrtka šestougaona (niska)

DIN 936

Bijeli cink



LUMEX

D.O.O.



Dimenzije
M3
M4
M5
M6
M8
M10
M12
M14
M16

NAVRTKE

Navrtka krilna

DIN 315

Bijeli cink



Dimenzije

M4

M5

M6

M8

M10

M12

NAVRTKE

Navrtka šestougaona (produžena)

DIN 6334
Bijeli cink



LUMEX



Dimenzije
M6
M8
M10
M12
M14
M16
M20

NAVRTKE

Navrtka zatvorena

DIN 1587

Bijeli cink



LUMEX

D.O.O.

Dimenzije
M4
M5
M6
M8
M10
M12
M14
M16
M20

NAVRTKE

Navrtka sa podloškom

DIN 6923
Bijeli cink



LUMEX
D.O.O



Dimenzije
M6
M8
M10
M12
M14
M16

NAVRTKE
Navrtka UNIT

08



LUMEX
D.O.O

Dimenzije
5x8
6x9
6x12
8x11
10x13

NAVRTKE

Navrtka sigurnosna

DIN 980 V ISO 7042

Materijal:čelik | inox Kvalitet: 8, 10|inox A2 Zaštita:pocinčano (ZN) Dimenzije: d(M): M4, M5, M6, M8, M10, M12, M14, M16,M18, M20, M22, M24



Navrtka sigurnosna (visoka)

DIN 982 M.B1.622 ISO 7040

Materijal:čelik | inox Kvalitet: 8, 10 | inox A2, A4 Zaštita:pocinčano (ZN) Dimenzije: d(M): M4, M6, M8, M10, M12, M14, M16, M18, M20, M22, M24

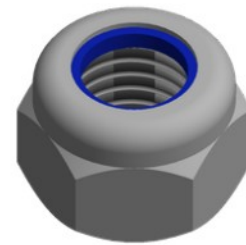

Navrtka šestougaona (niska)

DIN 439 M.B1.603 ISO 4036; 4035

Materijal:čelik|inox Kvalitet: 4, 8 |inox A2 Zaštita:pocinčano (ZN) Dimenzije: d(M): M4, M5, M6, M8, M10, M12, M14, M16, M18, M20, M22, M24, M27, M30, M33, M36, M39, M42



NAVRTKE

HV-šestougaona navrtka za čelične konstrukcije

DIN 6915 M.B1.629 ISO 7414

Materijal:čelik Kvalitet: 8 ,10

Zaštita:pocinčano

(ZN),brunirano (Br) Dimenzije:

d(M): M12, M14, M16, M18, M20,

M22, M24, M27, M30, M33, M36



Navrtka šestougaona (visoka)

DIN 6330 M.B1.607

Materijal:čelik | inox Kvalitet: 8 ,10

| inox A2 Zaštita:pocinčano (ZN)

,brunirano (Br) Dimenzije: d(M):

M6, M8, M10, M12, M16, M20, M24,

M27, M30

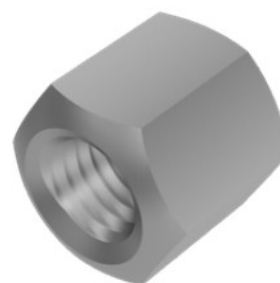

Navrtka šestougaona (visoka) sa vijencem

DIN 6331

Materijal:čelik | inox Kvalitet: 8 |

inox A2 Zaštita:pocinčano (ZN)

,brunirano (Br) Dimenzije: d(M):

M8, M10, M12, M14, M16, M18, M20,

M22, M24, M27, M30



NAVRTKE

Navrtka krunasta

DIN 935 M.B1.631 ISO 7035

Materijal:čelik | inox Kvalitet: 6 , 8

| inox A2 Zaštita:pocinčano (ZN)

Dimenzije: d(M): M6, M8, M10,

M12, M14, M16, M18,M20, M22, M24,

M27, M30, M33, M36, M39, M4

Navrtka krunasta (niska)

DIN 937 M.B1.634 ISO 7038

Materijal:čelik | inox Kvalitet: 8

|inox A2 Zaštita:pocinčano

(ZN),brunirano (Br) Dimenzije:

d(M): M6, M8, M10, M12, M14, M16,

M18,M20, M22, M24, M27, M30,

M33, M36, M39, M42

Navrtka šestougaona za zavarivanje

DIN 929 M.B1.625

Materijal:čelik Kvalitet: 8 Zaštita: FE

Dimenzije: d(M): M4, M5, M6, M8,

M10, M12



LUMEX
D.O.O



NAVRTKE

Navrtka prstenasta

DIN 582 M.B1.690

Materijal:čelik | inox Zaštita:
pocinčano (ZN) Dimenzije: d(M):
M6, M8, M10, M12, M14, M16,
M18,M20, M22, M24, M27, M30,
M33, M36, M39, M42



LUMEX
D.O.O



Navrtka kavezna

Materijal:čelik

Zaštita:pocinčano (ZN)

Dimenzije: d(M): M4, M5, M6,
M8



LUMEX

PODLOŠKY

09



PODLOŠKE Podloška ravna

DIN 125

Dimenzije	
M3	M16
M4	M18
M5	M20
M6	M22
M8	M24
M10	M27
M12	M30
M14	



LUMEX
D.O.O



Podloška elastična

DIN 127



Dimenzije	
M3	M16
M4	M18
M5	M20
M6	M22
M8	M24
M10	M27
M12	M30
M14	

PODLOŠKE Podloška široka

DIN 9021

Dimenzije	
M4	M20
M5	M22
M6	M24
M8	M27
M10	M30
M12	M33
M14	M36
M16	
M18	



LUMEX
D.O.O



Podloška zupčasta

DIN 6798

Dimenzije	
M3	M12
M4	M14
M5	M16
M6	M20
M8	M22
M10	M24

PODLOŠKE Podloška vulkanizirana

Dimenzije	
4,8x16	6,3x19
5,5x16	6,3x25
6,2x19	8,4x25



LUMEX
D.O.O



Podloška za salonit vijak

**M6 METALNE
M6 GUMENE**

PODLOŠKE

Podloška elastična

DIN 7980 M.B2.111

Materijal:čelik Zaštita: pocinčano (ZN), brunirano (Br) Dimenzije: d(M): M4, M5, M6, M8, M10, M12, M14, M16, M18, M20, M22, M24

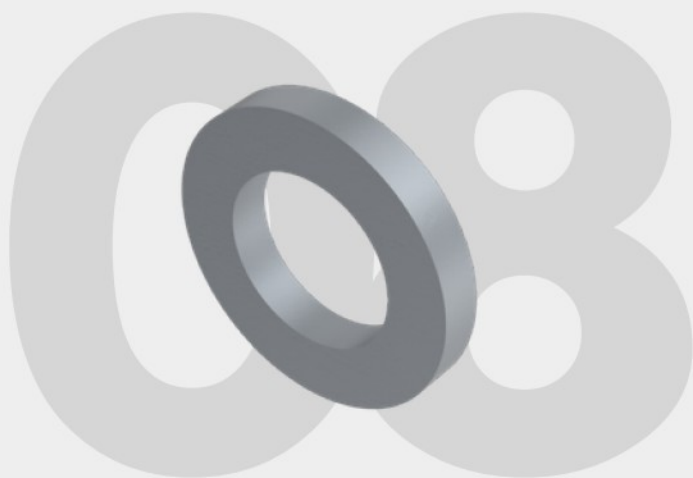

Podloška za vijke za čelične konstrukcije

DIN 7989 M.B2.015

Materijal:čelik Zaštita: pocinčano (ZN),TZN Dimenzije: d(M): M4, M5, M6, M8, M10, M12, M14, M16, M18, M20, M22, M24, M27, M30

PODLOŠKE

HV-podloška za čelične konstrukcije

DIN 6916 M.B2.030 ISO 7416

Materijal:čelik Zaštita:pocinčano (ZN),FE,TZN Dimenzije: d(M): M12, M14, M16, M18, M20, M22, M24, M27, M30, M33, M36



LUMEX
D.O.O



Podoška za drvenu konstrukciju

DIN 440 R

Materijal:čelik Zaštita:pocinčano (ZN), FE Dimenzije: d(M): M5, M6, M8, M10, M12, M14, M16, M18, M20, M22, M24

PODLOŠKE

Podloška za vijke sa cilindričnom glavom

DIN 433 M.B2.013 ISO 7092

Materijal: čelik | inox

Zaštita: pocinčano (ZN), TZN | inox
A2, Dimenzije: d(M): M4, M5, M6, M8, M10, M12, M14, M16, M18, M20, M22, M24, M27, M30

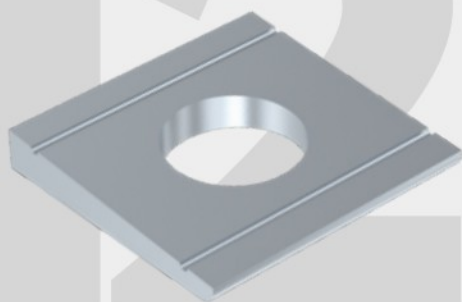

Kosa podloška za U-profil (nagib 8%)

DIN 434 M.B2.032

Materijal: čelik Zaštita: pocinčano (ZN), FE
Dimenzije: d(M): M8, M10, M12, M14, M16, M18, M20, M22, M24, M27, M30

Kosa podloška za I-profil (nagib 14 %)

DIN 435 M.B2.031

Materijal: čelik Zaštita: pocinčano (ZN), FE
Dimenzije: d(M): M8, M10, M12, M14, M16, M18, M20, M22, M24, M27, M30

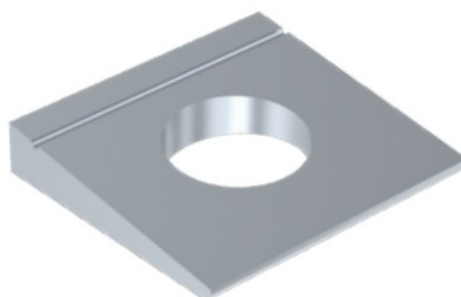

LUMEX



NAVOJNE ŠIPKE

10

NAVOJNE ŠIPKE
Navojna šipka

DIN 975
1M



LUMEX
D.O.O

KV 5.6	KV 8.8	KV 10.9
M4	-	-
M5	-	-
M6	-	-
M8	M8	M8
M10	M10	M10
M12	M12	M12
M14	M14	M14
M16	M16	M16
M18	M18	-
M20	M20	M20
M22	M22	M22
M24	M24	M24
M27	M27	M27
M30	M30	M30
-	M33	M33
M36	M36	M36

NAVOJNE ŠIPKE
Navojna šipka

DIN 975



LUMEX
D.O.O.

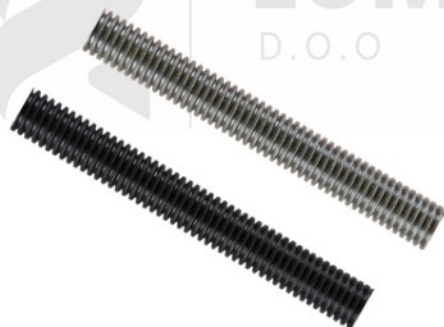

2 metra	3 metra
M8	M8
M10	M10
M12	M12
M16	
M18	
M20	

LUMEX

**POP
NITNE**

11



POP NITNE
Blok zakovice

DIN 7337
Aluminijum



LUMEX
D.O.O



Dimenzije	4.8 x 12	Proširena glava	FE
3.2 x 6	4.8 x 14	4 x 10	3.2 x 6
3.2 x 8	4.8 x 16	4 x 12	3.2 x 8
3.2 x 10	4.8 x 18	4 x 16	3.2 x 10
3.2 x 12	4.8 x 20	4.8 x 10	4 x 8
3.2 x 16	4.8 x 25	4.8 x 12	4 x 10
4 x 6	4.8 x 30	4.8 x 16	4 x 12
4 x 8	6 x 10	4.8 x 20	4.8 x 10
4 x 10	6 x 12		4.8 x 12
4 x 12	6 x 16		4.8 x 16
4 x 14	6 x 20		4.8 x 20
4 x 16	6 x 25		
4 x 18	6.4 x 12		
4 x 20			
4.8 x 8			
4.8 x 10			
4.8 x 12			

POP NITNE

Pop nitne u bojama

Crvena: RAL 3009
Zelena: RAL 6005 / RAL 6028
Antracit: RAL 7016
Braon: RAL 8017
Tamno braon: RAL 8019
Srebrna: RAL 9006
Bijela: RAL 9010
Crna: RAL 9005



LUMEX
D.O.O

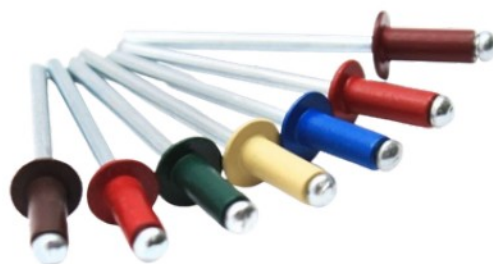

Dimenzije

3.2x8

3.2x10

4x10

4x12

LUMEX

OSTALO
12



Rascjepka

DIN 94
Bijeli cink



LUMEX
D.O.O



Dimenzije	Dimenzije	Dimenzije
2.5x20	5x45	10x100
2.5x28	5x50	10x140
2.5x36	5x56	
3.2x28	5x63	
3.2x32	5x71	
3.2x36	5x100	
3.2x40	6.3x50	
3.2x45	6.3x56	
3.2x50	6.3x63	
3.2x63	6.3x71	
3x40	6.3x125	
4x36	8x63	
4x40	8x80	
4x50	8x100	
4x71	8x140	
5x40	10x80	

Žabice za saju

DIN 741
Bijeli cink



LUMEX
D.O.O.



Dimenzije

3mm

5mm

6mm

8mm

10mm

13mm

14mm

16mm

19mm

22mm

Elastična čivija

DIN 1481

M.C2.230 ISO 8752

Materijal:čelik

Zaštita:brunirano (Br)

Dimenzije: d(M): M2, M4, M5,

M6, M8, M10, M12, M14, M16

l(mm): 10mm-180mm



LUMEX

D.O.O



Mazalice

DIN 71412

Materijal :čelik /inox



**PUR PJENA (sprejna) 180
fix&fill 750 ml**



**PUR PJENA SIKA 582
FOAM FIX 750 ml**



**PUR PJENA SIKA BOOM
580 (Pištoljska) 750 ml**



**SIKASIL WS-605 CRNI
600 ml**

**SIKA SILIKON AKRILNI
BIJELI 310 ml**

**SIKA SILIKON SANITARNI
BIJELI 300 ml**



LUMEX
D.O.O



Rezna ploča za metal/inox WEILER

Dimenzije:

115x1x22,2
125x1x22,2
180x1,6x22,2
230x1,9x22,2



Brusna ploča za metal WEILER

Dimenzije:

115x6x22,2
125x6x22,2
230x6x22,2



Lamelni disk za metal

G40
G60
G80
G100
G120



CO2 ŽICA APOLLO

0,8 x 5 kg
0,8 x 15 kg
1,0 x 15 kg
1,2 x 15 kg



Elektroda ORWELD

2,5 x 2,1 kg
3,25 x 3,40 kg



Streč folija

16

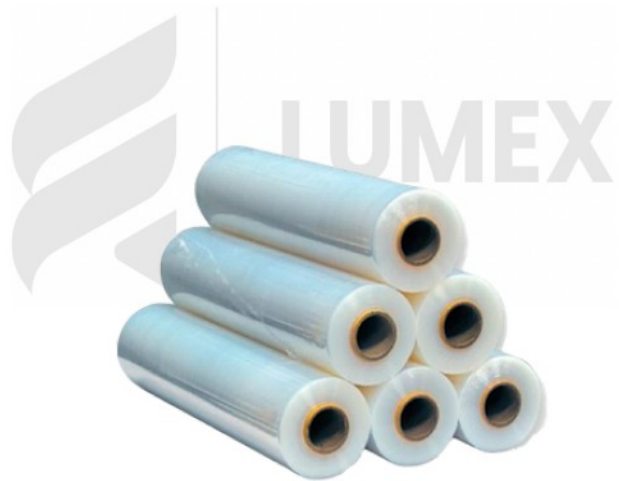

Distanceri za keramiku

17



LUMEX

INOX
12



INOX

Vijak sidreni (anker vijak)



Dimenzije	Dimenzije	Dimenzije
8x65	12x135	20x150
8x80	12x150	20x160
8x95	12x160	20x180
8x120	12x180	20x200
8x150	12x200	20x250
10x80	12x250	20x300
10x90	12x300	24x160
10x95	14x130	24x200
10x100	16x100	24x220
10x120	16x120	24x240
10x150	16x150	24x260
10x180	16x180	24x300
10x200	16x200	
12x80	16x250	
12x100	16x300	
12x120	20x120	

INOX

Vijak sa šestougaonom glavom (cijeli navoj)

DIN 933



LUMEX

DIN 933



Dimenzije	Dimenzije	Dimenzije	Dimenzije
4×10	5×40	8×12	10×20
4×12	5×50	8×16	10×25
4×16	6×10	8×20	10×30
4×20	6×12	8×25	10×35
4×25	6×16	8×30	10×40
4×30	6×20	8×35	10×45
4×35	6×25	8×40	10×50
4×40	6×30	8×50	10×60
4×50	6×35	8×60	10×70
5×10	6×40	8×70	10×80
5×12	6×50	8×80	10×90
5×16	6×60	8×90	10×100
5×20	6×70	8×100	10×120
5×25	6×80	8×120	10×150
5×30	6×90	8×140	12×20
5×35	6×100	8×150	12×25

INOX

Vijak sa šestougaonom glavom (Cijeli navoj)

DIN 933



LUMEX

D.O.O.

Dimenzije	Dimenzije	Dimenzije	Dimenzije	Dimenzije
12×30	14×45	16×80	20×60	24×120
12×35	14×50	16×90	20×70	24×140
12×40	14×60	16×100	20×80	27×60
12×45	14×70	16×110	20×90	27×70
12×50	14×80	16×120	22×50	27×80
12×60	14×90	16×130	22×80	27×100
12×70	14×100	16×140	22×100	30×50
12×80	14×120	18×40	22×120	30×60
12×90	14×150	18×50	22×130	30×70
12×100	16×30	18×60	22×140	30×80
12×120	16×35	18×70	24×50	30×90
12×140	16×40	18×80	24×60	30×100
12×150	16×45	18×100	24×70	30×120
14×30	16×50	18×120	24×80	30×150
14×35	16×60	20×40	24×90	
14×40	16×70	20×50	24×100	

INOX

Vijak sa šestougaonom glavom (djelimični navoj)

DIN 931



LUMEX
D.O.O



Dimenzije	Dimenzije	Dimenzije	Dimenzije
6x50	8x130	10x180	14x140
6x60	8x140	10x200	14x150
6x70	8x150	12x40	14x180
6x80	10x40	12x50	14x200
6x90	10x50	12x60	16x45
6x100	10x55	12x110	16x50
8x40	10x60	12x120	16x60
8x50	10x70	12x160	16x65
8x55	10x80	12x180	16x70
8x60	10x90	12x200	16x80
8x70	10x100	14x50	16x90
8x80	10x120	14x60	16x100
8x90	10x130	14x70	16x110
8x100	10x140	14x80	16x120
8x110	10x150	14x120	16x130
8x120	10x160	14x130	16x140

INOX

Vijak sa šestougaonom glavom (djelimični navoj)

DIN 931



LUMEX
D.O.O



Dimenzije	Dimenzije	Dimenzije	Dimenzije	Dimenzije
16x150	20x70	20x300	24x200	30x130
16x160	20x80	22x80	24x220	30x140
16x180	20x90	22x100	24x240	30x150
16x200	20x100	22x120	24x260	30x180
16x220	20x110	22x150	24x300	30x200
16x250	20x120	22x200	27x80	
16x300	20x130	24x60	27x100	
18x60	20x140	24x70	27x120	
18x70	20x150	24x80	27x150	
18x80	20x160	24x90	27x200	
18x90	20x170	24x100	30x70	
18x100	20x180	24x120	30x80	
18x110	20x200	24x140	30x90	
18x120	20x220	24x150	30x100	
18x150	20x240	24x160	30x110	
20x60	20x250	24x180	30x120	

INOX
Torban vijak

DIN 603



LUMEX
D.O.O



Dimenzije	Dimenzije	Dimenzije	Dimenzije	Dimenzije
5x16	6x40	8x35	10x20	12x70
5x20	6x45	8x40	10x25	12x80
5x25	6x50	8x45	10x30	12x90
5x30	6x55	8x50	10x40	12x100
5x35	6x60	8x55	10x45	12x120
5x40	6x65	8x60	10x50	
5x45	6x70	8x65	10x60	
5x50	6x80	8x70	10x70	
5x60	6x90	8x75	10x80	
5x70	6x100	8x80	10x90	
6x12	6x110	8x90	10x100	
6x16	6x120	8x100	10x120	
6x20	6x150	8x120	10x150	
6x25	8x20	8x130	12x40	
6x30	8x25	8x140	12x50	
6x35	8x30	8x150	12x60	

INOX

Vijak imbus sa cilindričnom glavom

DIN 912



LUMEX

D.O.O



Dimenzije	Dimenzije	Dimenzije
6x12	8x70	12x50
6x16	8x80	12x60
6x20	8x90	12x70
6x25	8x100	12x80
6x30	10x20	
6x40	10x25	
6x50	10x30	
8x16	10x35	
8x20	10x40	
8x25	10x50	
8x30	10x60	
8x35	10x70	
8x40	10x80	
8x45	12x30	
8x50	12x35	
8x60	12x40	

INOX

Vijak imbus sa upuštrenom glavom

DIN 7991

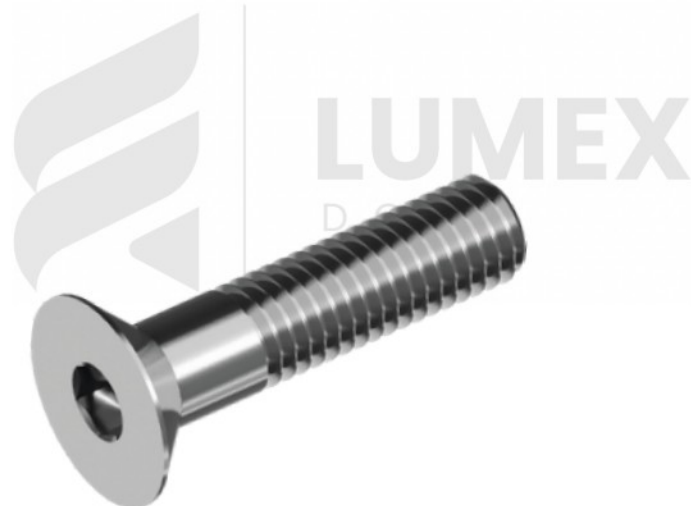

Dimenzije

6x16

6x20

6x25

6x30

6x40

8x16

8x20

8x25

8x30

8x35

8x40

8x50

8x60

8x70

8x80

10x20

Dimenzije

10x25

10x30

10x35

10x40

10x50

12x30

12x35

12x40

12x50

VIJCI S METRIČKIM NAVOJEM

Vijak sa upuštenom glavom (krstasti urez)

DIN 965
Bijeli cink

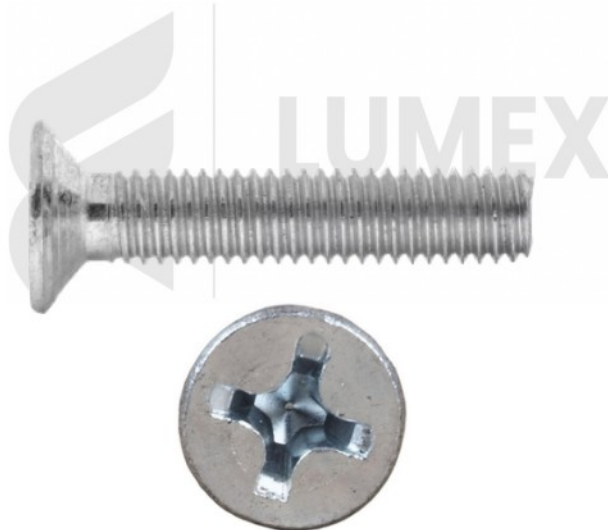

Dimenzije	Dimenzije	Dimenzije	Dimenzije	Dimenzije
3x6	4x30	5x50	6x50	10x30
3x8	4x35	5x55	6x60	10x40
3x10	4x40	5x60	6x70	10x50
3x12	4x45	5x70	6x80	10x60
3x16	4x50	5x80	8x16	10x65
3x20	4x60	5x90	8x20	
3x25	5x8	5x100	8x25	
3x30	5x10	6x10	8x30	
3x40	5x12	6x12	8x35	
4x6	5x16	6x16	8x40	
4x8	5x20	6x20	8x45	
4x10	5x25	6x25	8x50	
4x12	5x30	6x30	8x60	
4x16	5x35	6x35	8x70	
4x20	5x40	6x40	8x80	
4x25	5x45	6x45	10x25	

Imbus vijak, ravna (lećasta) glava (sa podloškom)

ISO 7380 1/2

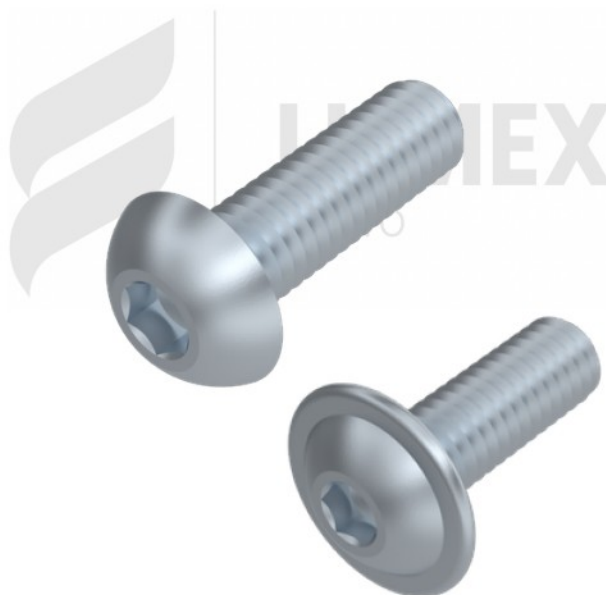

Navrtka sa podloškom

DIN 6923

Dimenzije
M6
M8
M10
M12
M14
M16



Navrtka šestougaona (niska)

DIN 439 M.BI.603 ISO 4036; 4035

Materijal:čelik|inox Kvalitet: 4, 8
|inox A2 Zaštita:pocinčano (ZN)
Dimenzije: d(M): M4, M5, M6, M8,
M10, M12, M14, M16, M18, M20, M22,
M24, M27, M30, M33, M36, M39, M42



INOX

Vijak za drvo sa šestougaonom glavom

DIN 571



LUMEX

D.O.O

Dimenzije
6x30
6x40
6x50
6x60
6x70
6x80
6x90
6x100
6x110
6x120
6x140
6x150
6x180
6x200
8x40
8x50

Dimenzije
8x60
8x70
8x80
8x90
8x100
8x120
8x140
8x150
8x160
8x180
8x200
8x220
8x250
10x60
10x70
10x80

Dimenzije
10x90
10x100
10x120
10x150
10x180
10x200
10x220
10x250
10x300
12x80
12x100
12x120
12x150
12x180
12x200
12x220

Dimenzije
12x250
12x300

INOX

Vijak za lim (ravna glava)

DIN 7981



Dimenzije	Dimenzije	Dimenzije	Dimenzije
2.9x6.5	3.9x9.5	4.2x50	5.5x38
2.9x9.5	3.9x13	4.8x9.5	5.5x50
2.9x13	3.9x16	4.8x13	6.3x13
2.9x16	3.9x19	4.8x16	6.3x16
2.9x19	3.9x22	4.8x19	6.3x19
2.9x22	3.9x25	4.8x22	6.3x22
2.9x25	3.9x32	4.8x25	6.3x25
3.5x6.5	3.9x38	4.8x32	6.3x32
3.5x9.5	4.2x9.5	4.8x38	6.3x38
3.5x13	4.2x13	4.8x50	6.3x45
3.5x16	4.2x16	5.5x13	6.3x50
3.5x19	4.2x19	5.5x16	6.3x60
3.5x22	4.2x22	5.5x19	6.3x70
3.5x25	4.2x25	5.5x22	
3.5x32	4.2x32	5.5x25	
3.9x6.5	4.2x38	5.5x32	

VIJCI ZA LIM

Vijak za lim (upuštena glava)

DIN 7982



Dimenzije	Dimenzije	Dimenzije
2.9x6.5	3.9x13	4.2x45
2.9x9.5	3.9x16	4.8x13
2.9x13	3.9x19	4.8x16
2.9x16	3.9x22	4.8x19
2.9x19	3.9x25	4.8x22
2.9x22	3.9x32	4.8x25
2.9x25	3.9x38	4.8x32
3.5x6.5	3.9x45	4.8x38
3.5x9.5	4.2x9.5	4.8x45
3.5x13	4.2x13	4.8x50
3.5x16	4.2x16	5.5x19
3.5x19	4.2x19	5.5x38
3.5x22	4.2x22	6.3x38
3.5x25	4.2x25	6.3x70
3.5x32	4.2x32	
3.9x9.5	4.2x38	

INOX

Vijak za lim samourezivi (upuštena glava - oblik P)

DIN 7504



Dimenzije	Dimenzije
3.9x13	4.8x35
3.9x16	4.8x38
3.9x19	4.8x50
3.9x22	4.8x60
3.9x25	4.8x70
3.9x32	4.8x80
3.9x38	5.5x19
4.2x16	5.5x25
4.2x19	5.5x32
4.2x25	5.5x38
4.2x32	5.5x50
4.2x38	5.5x60
4.2x50	5.5x70
4.8x16	5.5x80
4.8x19	6.3x25
4.8x25	6.3x32
4.8x32	6.3x38

INOX

Vijak za lim samourezivi (cilindrična glava - oblik N)

DIN 7504



Dimenzije
3.5x13
3.5x16
3.5x19
3.9x13
3.9x16
3.9x19
3.9x22
3.9x25
3.9x32
3.9x38
4.2x16
4.2x19
4.2x25
4.2x32
4.2x38
4.2x50

Dimenzije
4.8x16
4.8x19
4.8x25
4.8x32
4.8x35
4.8x38
4.8x50
4.8x60
4.8x70
4.8x80
5.5x19
5.5x25
5.5x32
5.5x38
5.5x50
5.5x60

Dimenzije
5.5x70
5.5x80
6.3x25
6.3x32
6.3x38

INOX

Vijak za lim samourezivi (šestougaona glava - oblik K)



Dimenzije	Dimenzije	Dimenzije
4.2x13	5.5x25	6.3x80
4.2x16	5.5x32	6.3x90
4.2x19	5.5x38	6.3x100
4.2x22	5.5x50	6.3x110
4.2x25	5.5x60	6.3x120
4.2x32	5.5x70	6.3x140
4.2x38	5.5x80	6.3x150
4.8x16	6.3x19	6.3x160
4.8x19	6.3x22	6.3x180
4.8x25	6.3x25	6.3x200
4.8x32	6.3x32	6.3x220
4.8x35	6.3x38	6.3x250
4.8x38	6.3x45	
4.8x50	6.3x50	
4.8x70	6.3x60	
5.5x19	6.3x70	

INOX
Hangar vijak



Namjena i Dimenzije	Namjena i Dimenzije	Namjena i Dimenzije
DRVO (D.D.) 6x70	METAL/DRVO. 6x70	METAL/UNIV. 10x120
DRVO (D.D.) 6x80	METAL/DRVO. 6x80	METAL/UNIV. 10x140
DRVO (D.D.) 6x90	METAL/DRVO 6x90	
DRVO (D.D.) 8x80	METAL/DRVO 8x60	
DRVO (D.D.) 8x90	METAL/DRVO. 8x70	
DRVO (D.D.) 8x100	METAL/DRVO 8x80	
DRVO (D.D.) 8x120	METAL/DRVO. 8x90	
	METAL/DRVO 8x100	
	METAL/DRVO. 8x120	
	METAL/DRVO. 8x140	
	METAL/DRVO. 8x150	
	METAL/DRVO. 8x180	
	METAL/DRVO. 8x200	
	METAL/DRVO. 10x80	
	METAL/DRVO. 10x90	
	METAL/DRVO. 10x100	

INOX
Navojna šipka

DIN 975
1M



Dimenzije
M4
M5
M6
M8
M10
M12
M14
M16
M18
M20
M22
M24
M27
M30
M33
M36

INOX
Navrtka šestougaona

DIN 934



INOX	M18	Korak 1.5
M3	M20	M10
M4	M22	M12
M5	M24	M14
M6	M27	M16
M8	M30	M18
M10	M33	M20
M12	M36	
M14		
M16		

INOX

Vijak sa cilindričnom glavom (krstasti urez)

DIN 7985



LUMEX
D.O.O



Dimenzije	Dimenzije	Dimenzije	Dimenzije	Dimenzije
3x5	4x6	5x12	6x30	8x60
3x6	4x8	5x16	6x35	8x70
3x8	4x10	5x20	6x40	8x80
3x10	4x12	5x25	6x45	
3x12	4x16	5x30	6x50	
3x16	4x20	5x35	6x55	
3x20	4x25	5x40	6x60	
3x25	4x30	5x45	8x12	
3x30	4x35	5x50	8x16	
3x35	4x40	5x55	8x20	
3x40	4x45	5x60	8x25	
3x45	4x50	6x10	8x30	
3x50	4x60	6x12	8x35	
3.5x6	5x6	6x16	8x40	
3.5x8	5x8	6x20	8x45	
3.5x10	5x10	6x25	8x50	

INOX

Navrtka zatvorena

DIN 1587

Bijeli cink



Dimenzije
M4
M5
M6
M8
M10
M12
M14
M16
M20

INOX

Navrtka sa podloškom

DIN 6923



Dimenzije
M6
M8
M10
M12
M14
M16

INOX

Navrtka šestougaona (produžena)

DIN 6334



LUMEX



Dimenzije
M6
M8
M10
M12
M14
M16
M20

INOX

Navrtka krilna

DIN 315

Bijeli cink



Dimenzije

M4

M5

M6

M8

M10

M12

Navrtka šestougaona za zavarivanje

DIN 929 M.B1.625

Dimenzije: d(M): M4, M5, M6,
M8, M10, M12



INOX Podloška široka

DIN 9021

Dimenzije	
M4	M20
M5	M22
M6	M24
M8	M27
M10	M30
M12	M33
M14	M36
M16	
M18	

Vijak imbus sa cilindričnom glavom (niska glava)

DIN 7984 M.B1.125 ISO 14580

Materijal:čelik Kvalitet: 8,8 10,9

Zaštita:pocinčano (Zn) ,brunirano

(Br) Dimenzije: d(M): M8, M10, M12,
M14, M16, M18, M20, M22, M24 l(mm):

16mm-150mm



LUMEX
D.O.O





Dimenzije	
M3	M16
M4	M18
M5	M20
M6	M22
M8	M24
M10	M27
M12	M30
M14	

INOX
Blok zakovice

DIN 7337



Dimenzije	4.8 x 12	Proširena glava	FE
3.2 x 6	4.8 x 14	4 x 10	3.2 x 6
3.2 x 8	4.8 x 16	4 x 12	3.2 x 8
3.2 x 10	4.8 x 18	4 x 16	3.2 x 10
3.2 x 12	4.8 x 20	4.8 x 10	4 x 8
3.2 x 16	4.8 x 25	4.8 x 12	4 x 10
4 x 6	4.8 x 30	4.8 x 16	4 x 12
4 x 8	6 x 10	4.8 x 20	4.8 x 10
4 x 10	6 x 12		4.8 x 12
4 x 12	6 x 16		4.8 x 16
4 x 14	6 x 20		4.8 x 20
4 x 16	6 x 25		
4 x 18	6.4 x 12		
4 x 20			
4.8 x 8			
4.8 x 10			
4.8 x 12			